

D V 6 9

Ø 3 p ñ€ 00 06

3DUDPHWHU	6\PERO	/LPLW	8QLW
'UDLQ VRXUFH 9ROWDJH	9 <sub>6</sub>		9
*DWH VRXUFH 9ROWDJH	6	9 f	9
'UDLQ &XUUHQW	.	,	P\$
3XOVHG 'UDLQ &XUUHQW	'0		\$
7RWDO 3RZHU 'LVVLSDWLRQ # 7	3		P:
7KHUPDO 5HVLWLRQVWRXUFH ELHQW%# 6WHDG\ 6WDWH	G\ 6WDWH		5 :
-XQFWLRQ DQG 6WRUDJH 7HPSHUDWXUH 5DQJH . 77	DQJH . 77	7	

v 2 UGHULQJ , QIRUPDSVLRQ

35() (5(' 3 1	3\$&.,1* &2'()	0DUNLQJ	0,1,080 3\$&.\$*( SF	,11(5 %2; 48\$17,7< S	287(5 &\$572 48\$17,7< S	'(/,9(5< 02'()
1 .'' :4	)	.				3 UHHO



v(OHFWULFDO & KDZDFW\HQLNWLFRWKHUZLVH QRWHG

3DUDPHWHU	6\PERC	&RQGLWLRQV	0LQ	7\S	0D[	8QLWV
6WDWLF 3DUDPHWHU						
'UDLQ 6RXUFH %UHDNGRZC	9ROWDJH	·6 9%9, \$	9			9
=HUR *DWH 9ROWDJH 'UDLQ &XUHQW		9·6 9 9·6 ,9 7M				

\*DWH %RG\ /HDNDJH &XUHQW·66 9·6, f 9 9 9 f \$





5 6 RQ 'UDLQ WR 6RXUFH UHVLVWDQFH

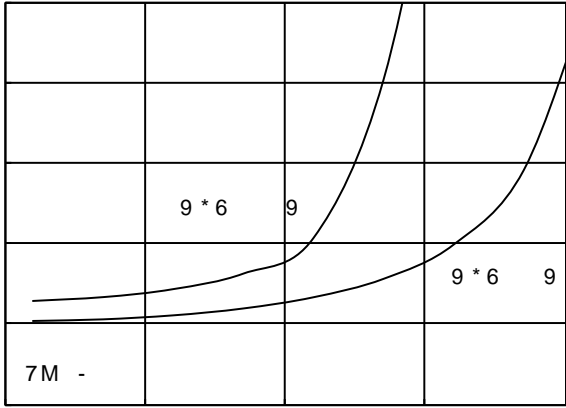

, 'UDLQ & XUHHQW \$

,V5HYHUVH 'UDLQ & XUHHQW \$

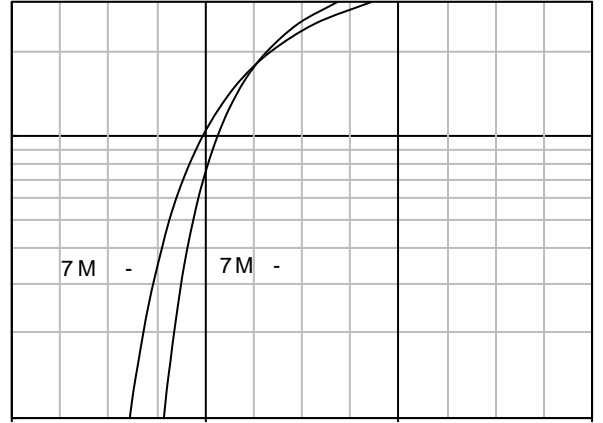

9 V 6RXUFH WR 'UDLQ 9 ROWDJH 9

%966 0\$; 'UDLQ WR 6RXUFH 9ROV 1RUPDOLJHG

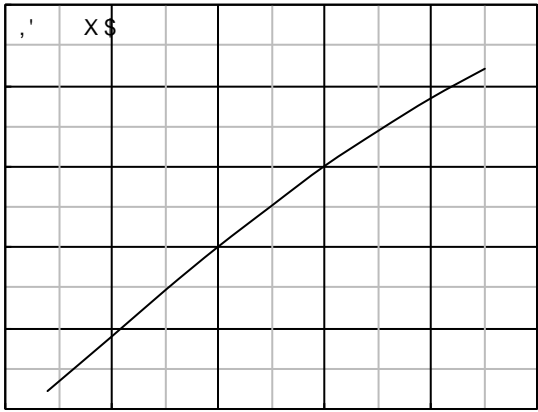

7MXQFWLRQ 7HPSHUDWXUH

5 6) 6 UHDLQ & XUHHQW \$

9 6 WKUHVKROG 9ROWDJH 1RUPDOLJHG

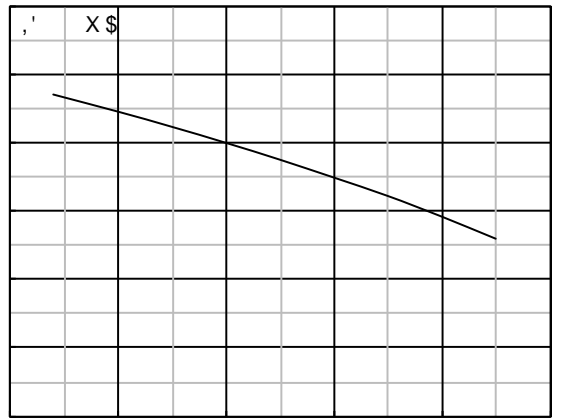

7MXQFWLRQ 7HPSHUDWXUH

)RUZDUG FKDUDFWHMULVWLFV

)LJXUH 1RUPDOLJHG 7HPSHUDWXUH

)LJXUH 1RUPDOLJHG 7KUH

Blank lined area for writing.

)LJXUH 0D[LXP7KUHQRVHGQFH

)LJXUH 6DIH 2SHUDV



v 7HVW & LUFXLWV :DYHIRUPV

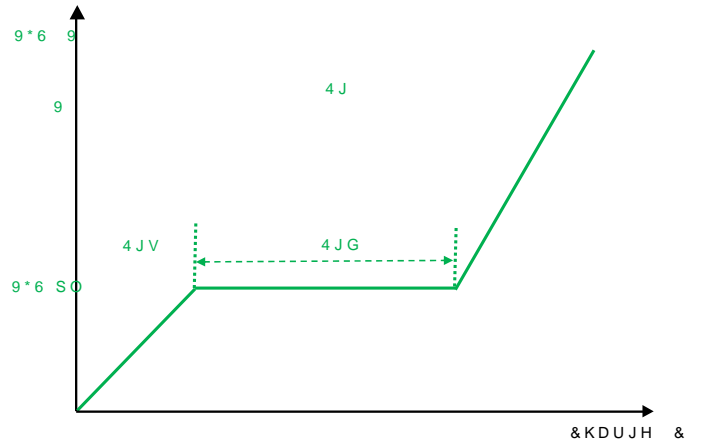
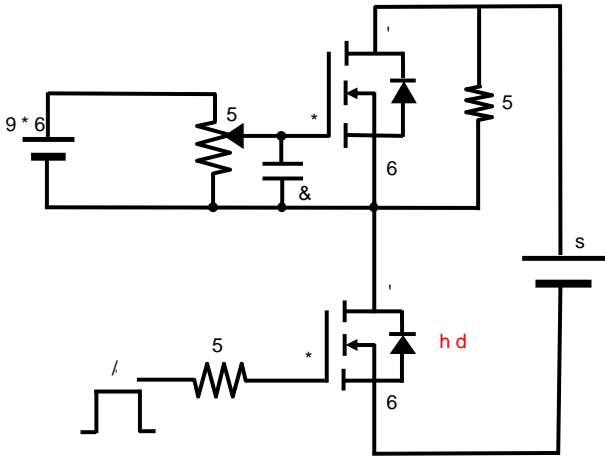

)LJXUHDWH &KDUJHUFXLW & :DYHIRUP

)LJXUHFHVLVWLYH 6ZLW&KULQLWH :DYHIRUP

)LJXUHL&GH 5HFRYHU\ 7HVW &LUFXLW :DYHIRUP



v 6 2 7 3 D F N D J H 2 X W O L Q H ' L P H Q V L R Q V

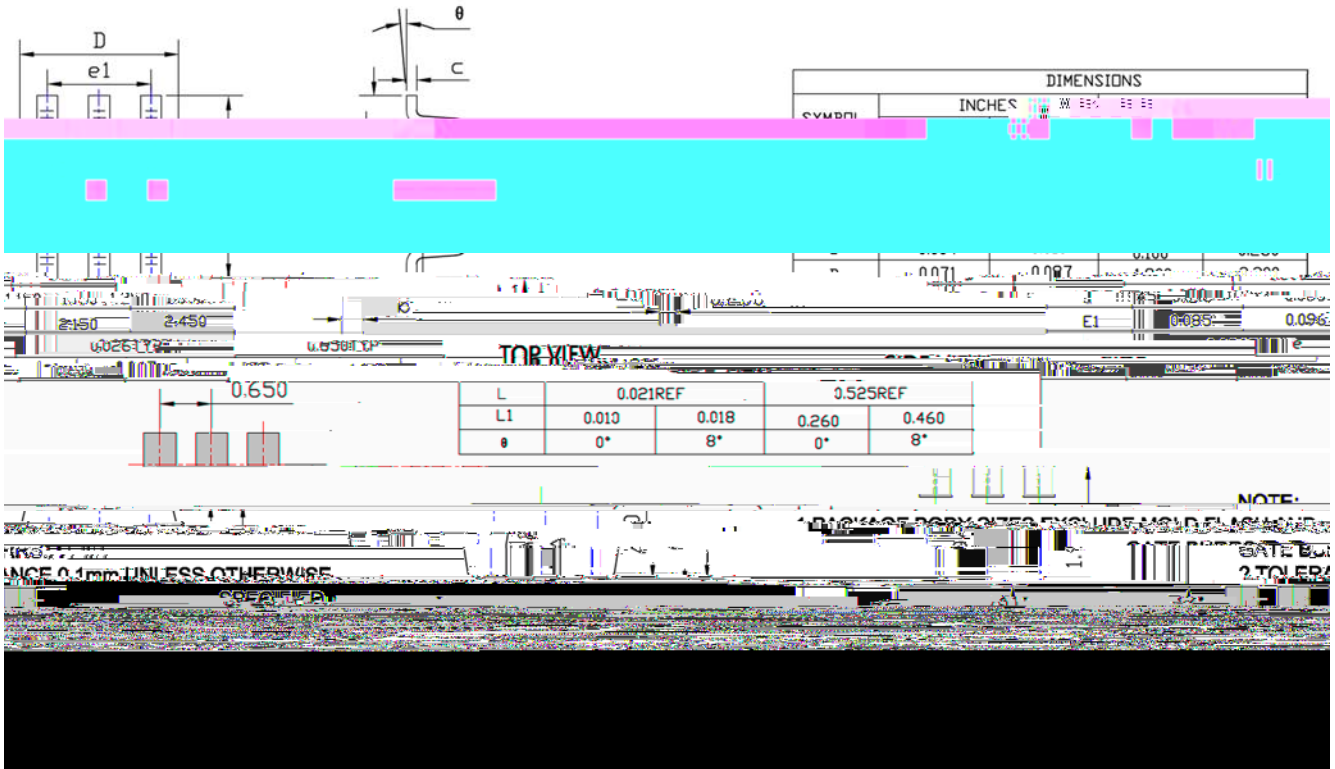

v 0 D U N L Q J , Q I R U P D W L R Q

1 R W H

'LVFODLPHU

7KH LQIRUPDWLRQ LSU ~~SRFH~~ ~~PH~~ ~~GWL~~ ~~QVM~~ ~~RU~~ <DQJJKRX <DQJMLH (OHFWURQLF 7HHKQRO  
ULJKW WR PDNH FKDQJHV ZL KB€F @ p HPK°