



Moisture Sensitivity Level 1
Surface mount package ideally Suited for Automatic
Insertion
Epoxy meets UL-94 V-0 flammability rating, halogen-free

: SOT-523
: Tin plated leads, solderable per
J-STD-002 and JESD22-B102
1P

(Ta=25 Unless otherwise specified)

Collector-Emitter Voltage	V_{CEO}	V	$I_C=10\text{mAdc}, I_B=0$	40
Collector-Base Voltage	V_{CBO}	V	$I_C=10\text{uAdc}, I_E=0$	75
Emitter-Base Voltage	V_{EBO}	V	$I_E=10\text{uAdc}, I_C=0$	6



(Typical)

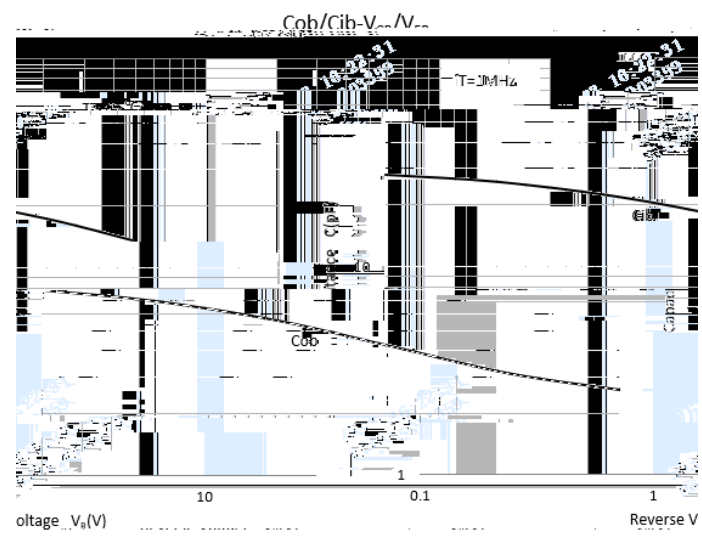
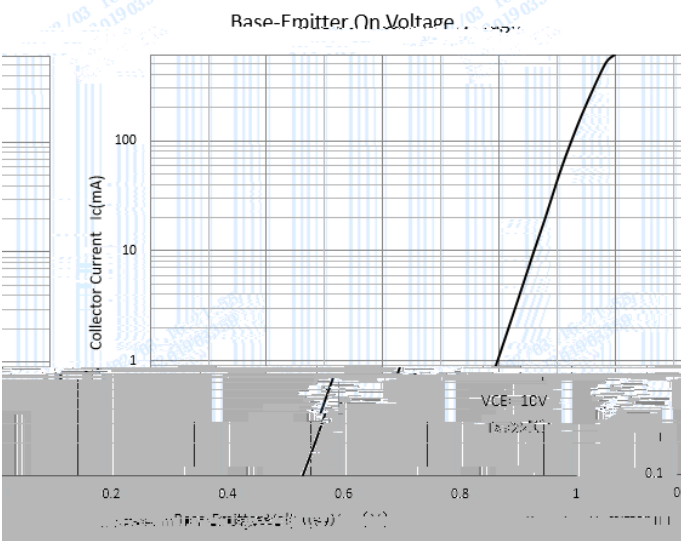
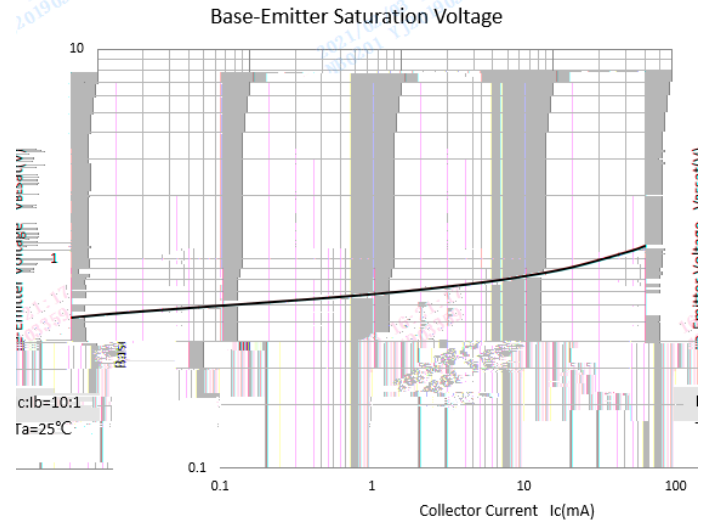
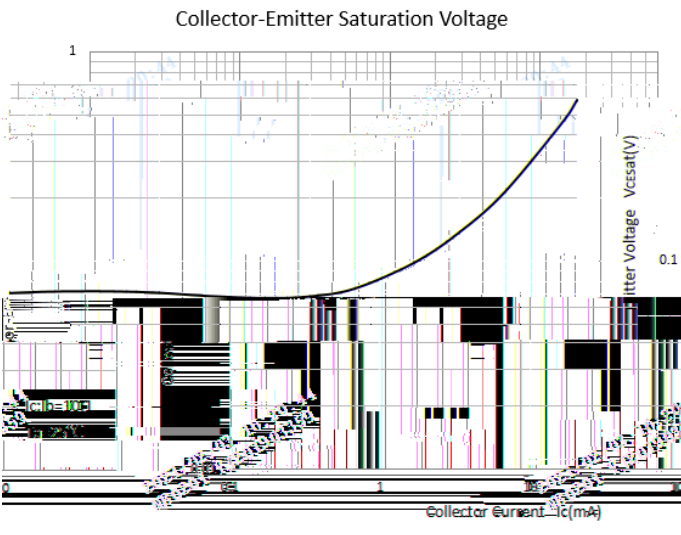
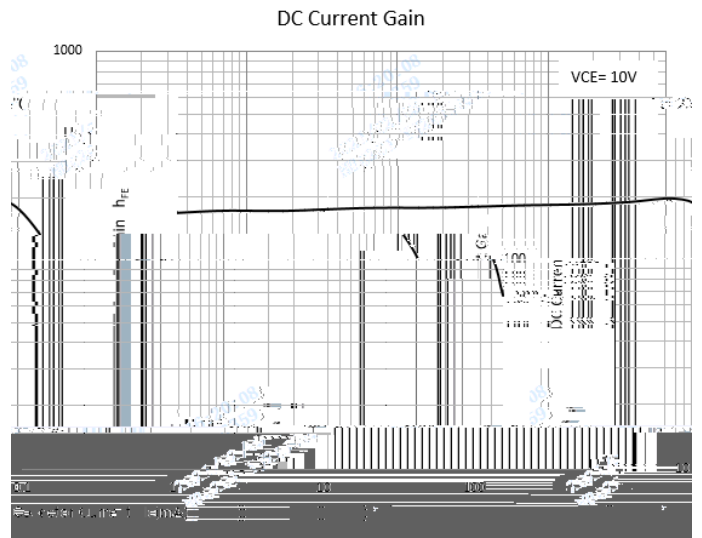
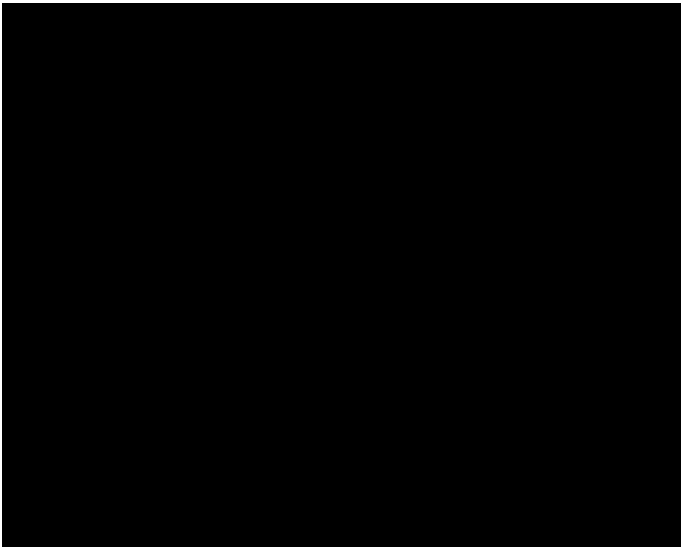



16-23
19-03-36

Collector Power Derating Curve

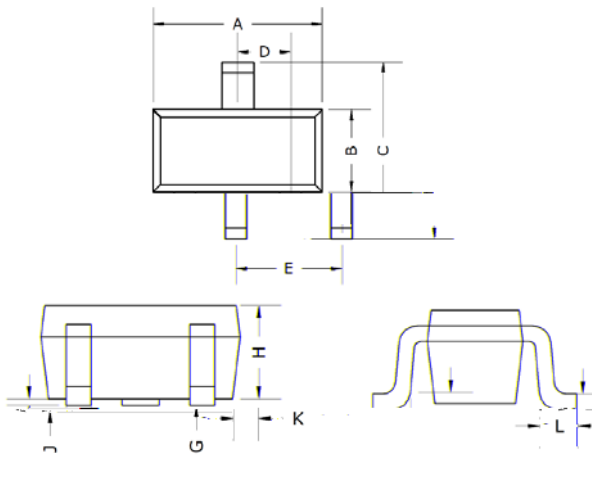
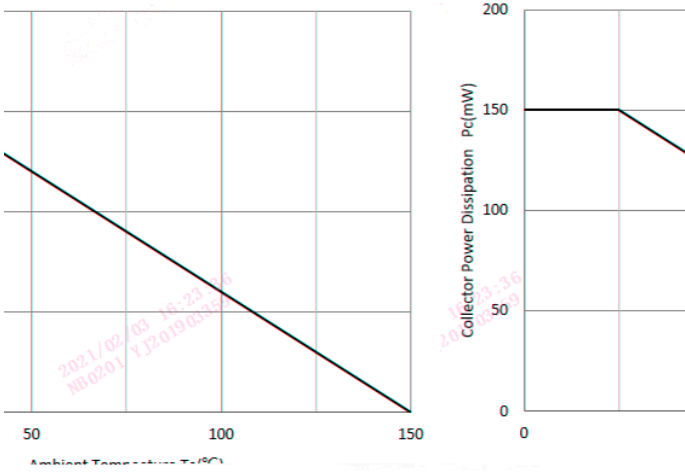

MAX DIM	DIMENSIONS			
	INCHES		MM	
	MIN	MAX	MIN	MAX
1.70	A	0.059	0.067	1.50
0.85	B	0.030	0.033	0.75

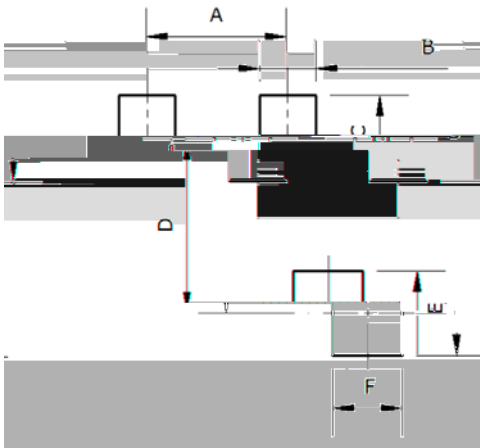

DIMENSIONS	
DIM	MM (TYP)
A	1.00
B	0.40
C	0.60
D	1.24
0.50	F



The information presented in this document is for reference only. Yangzhou Yangjie Electronic Technology Co., Ltd. reserves the right to make changes without notice for the specification of the products displayed herein to improve reliability, function or design or otherwise.

The product listed herein is designed to be used with ordinary electronic equipment or devices, and not designed to be used with equipment or devices which require high level of reliability and the malfunction of which would directly endanger human life (such as medical instruments, transportation equipment, aerospace machinery, nuclear-reactor controllers, fuel controllers and other safety devices), Yangjie or anyone on its behalf, assumes no responsibility or liability for any damages resulting from such improper use of sale.

This publication supersedes & replaces all information previously supplied. For additional information, please visit our website [http:// www.21yangjie.com](http://www.21yangjie.com) , or consult your nearest Yangjie's sales office for further assistance.